

N.O.F. / Inc.



6' Heavy Duty Wood Picnic Table -Portable.

- 156 - 195 Lbs.
- Overall Dimensions: 72"L x 62"W x 30"H..
- Frame available in 1 5/8" and 2 3/8" O.D. pipe with 1 5/16" O.D. brace.
- All MIG welded frame with zinc or galvanized plated hardware.
- Pre-drilled holes for surface mounting frame.
- Zinc coated, galvanized, powder coated or galvanized legs.
- Without umbrella hole.
- Available in 2" x 10" untreated pine, treated pine and redwood stained pine planks.
- Some assembly required.

Item #: US 158-6

Number	Description
US 158-U6	6' Table, 1 5/8" O.D. Pipe, Untreated Pine, Portable.
US 158-PT6	6' Table, 1 5/8" O.D. Pipe, Treated Pine, Portable.
US 158-T6	6' Table, 1 5/8" O.D. Pipe, Redwood Stained Pine, Portable.
US 238-U6	6' Table, 2 3/8" O.D. Pipe, Untreated Pine, Portable.
US 238-PT6	6' Table, 2 3/8" O.D. Pipe, Treated Pine, Portable.
US 238-T6	6' Table, 2 3/8" O.D. Pipe, Redwood Stained Pine,

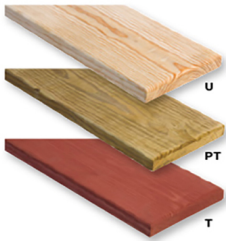

Wood Planks

2" x 10" and 2" x 4" sizes
Rounded Edges
#1 Southern Yellow Pine

(U) Untreated
(PT) Pressure Treated
Environmentally Friendly ACQ
Kiln Dried Before & After Treatment
(T) Treated Stain
Sealed in Redwood Stain With
Wood Preservative

Standard Powder Coat Colors



BURGUNDY



RED



ORANGE



YELLOW



SPRING GREEN



GREEN



NEW ROYAL PURPLE



ULTRA BLUE



BLUE



SKY BLUE



BEIGE



BROWN

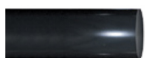

BLACK



MATTE BLACK

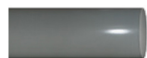

DARK GREY



NEW CHAMPAGNE



WHITE

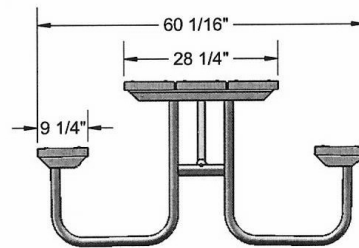
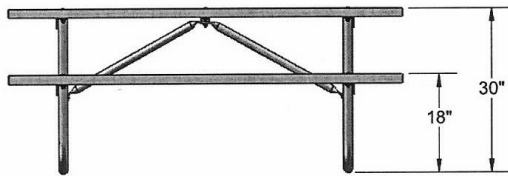
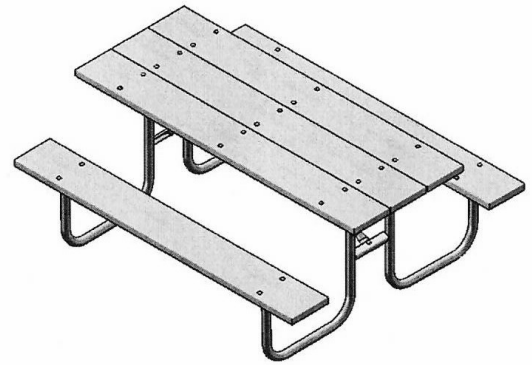
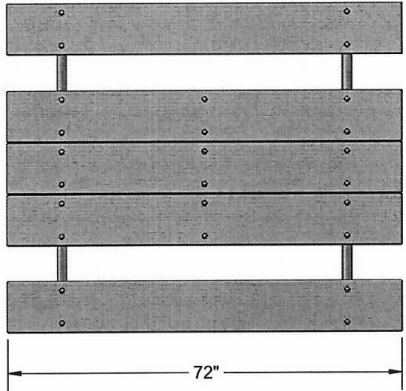

NATIONAL OUTDOOR FURNITURE, INC.
 1210 W. Main Street #296 Riverhead, NY 11901
 Toll-Free Phone: 1-888-663-4621
 Phone: 631-369-9099 Fax: 631-207-8312
 Email: nofinc@optonline.net
www.nationaloutdoorfurniture.com

NATIONAL OUTDOOR FURNITURE, INC.
 144 Murdock Road #325 Pomfret Center, CT 06259
 Toll-Free Phone: 1-888-516-8873
 Phone: 1-860-974-9996 Fax: 516-706-1901
 Email: nofinc@earthlink.net
www.nationaloutdoorfurniture.com