



**Adjustable ADA Rotating Grill, 280 and 300 Square Inch - Inground Mount.**

- 280 or 300 Total square inch cooking surface.
- 280 Sq. Inche Firebox size: 20"L x 14"D x 8"H.
- 300 Sq. Inche Firebox size: 20"L x 15"D x 10"H.
- 2 3/8" and 3 1/2" posts available.
- Grill rotates a full 360 degrees.
- Cooking grate has cool-coil handles and can be adjusted to four different levels.
- All MIG welded 7 gauge base plate with 10 gauge side plate.
- Galvanized iron pipe post. Inground mount.
- Durable rust resistant high temp black powder coated firebox.
- ADA, surface mounted and inground mounted versions available.
- Optional hot dipped galvanized firebox and utility shelf.
- Some assembly required.

**Item #:** US 620H

Model Number	Description
US 620H	ADA Gril 280 Sq. Inches with 2 3/8" O.D. Post, 49 Lbs., Inground Mount.
US 620H3	ADA Grill, 280 Sq. Inches with 3 1/2" O.D. Post, 56 Lbs., Inground Mount.
US 630H-3-U	ADA Grill, 300 Sq. Inches with 3 1/2" O.D. Post, 85 Lbs.,Utility Shelf Inground Mount

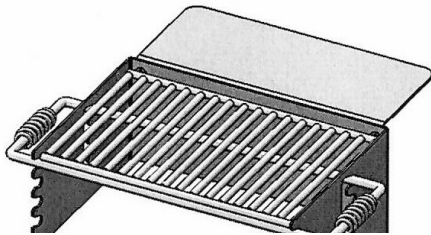

**Optional Utility Shelf**

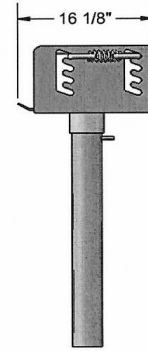
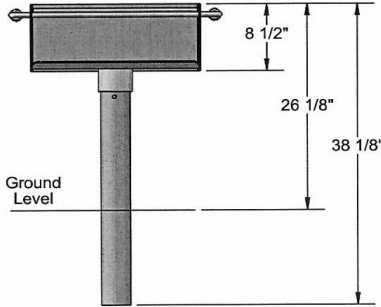
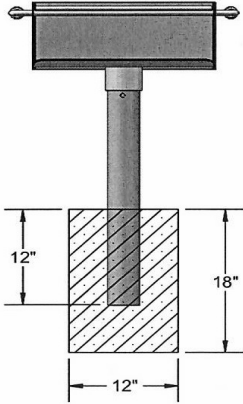
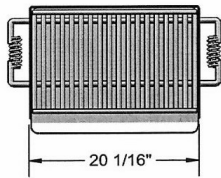
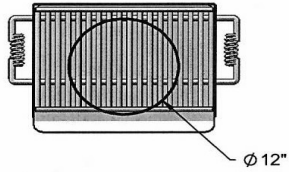

**US 620H-3**

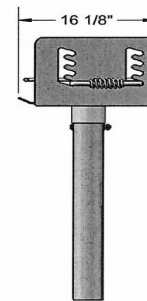
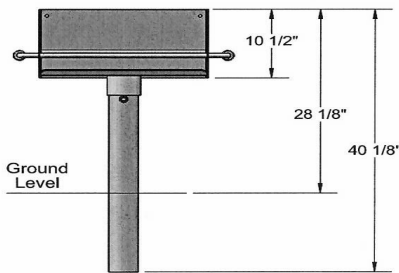
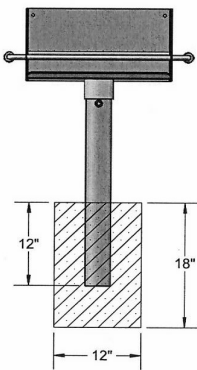
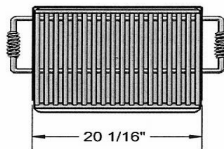
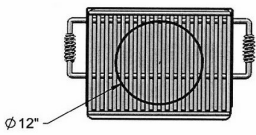

**US 630H-3**

Estimated Required Concrete:  
4 - 50lb Bags of Concrete Mix

**NATIONAL OUTDOOR FURNITURE, INC.**  
1210 W. Main Street #296 Riverhead, NY 11901  
Toll-Free Phone: 1-888-663-4621  
Phone: 631-369-9099 Fax: 631-207-8312  
Email: [nofinc@optonline.net](mailto:nofinc@optonline.net)  
[www.nationaloutdoorfurniture.com](http://www.nationaloutdoorfurniture.com)

**NATIONAL OUTDOOR FURNITURE, INC.**  
144 Murdock Road #325 Pomfret Center, CT 06259  
Toll-Free Phone: 1-888-516-8873  
Phone: 1-860-974-9996 Fax: 516-706-1901  
Email: [nofinc@earthlink.net](mailto:nofinc@earthlink.net)  
[www.nationaloutdoorfurniture.com](http://www.nationaloutdoorfurniture.com)