

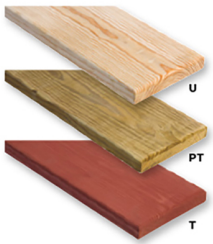

8' Heavy Duty Table - ADA Portable.

- Overall Dimensions: 95”L x 60 1/6”D x 30”H.
- Available as ADA accessible table in single or double sided accessibility.
- Wood style or aluminum style 2” x 10” planks.
- All MIG welded frame with zinc plated hardware.
- Frame available in 1 5/8” and 2 3/8” O.D. pipe with 1 5/16” O.D. brace.
- Zinc coated, galvanized, powder coated finish or galvanized frame.
- Available in Untreated Pine, Treated Pine, Redwood Stained Pine and Aluminum Planks.
- Some assembly required.

Item #: US 158H



Wood Planks

2” x 10” and 2” x 4” sizes
Rounded Edges
#1 Southern Yellow Pine

(U) Untreated
(PT) Pressure Treated
Environmentally Friendly ACQ
Kiln Dried Before & After Treatment
(T) Treated Stain
Sealed in Redwood Stain With
Wood Preservative

Standard Powder Coat Colors

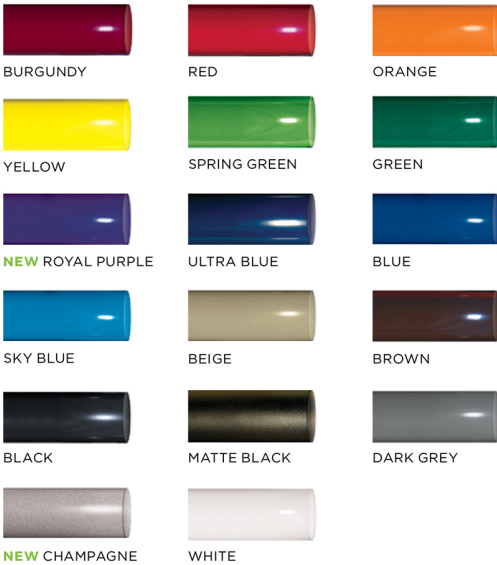

Model Number	Description
US 158HS-U8	8’ ADA Table, 180 Lbs., One Sided, 1 5/8” O.D. Pipe, Untreated Pine, Portable.
US 158HS -PT8	8’ ADA Table, 180 Lbs., One Sided, 1 5/8” O.D. Pipe, Treated Pine, Portable.
US 158HS -T8	8’ ADA Table, 180 Lbs., One Sided, 1 5/8” O.D. Pipe, Redwood Stained Pine, Portable.
US 158HS -A8	8’ ADA Table, 142 Lbs., One Sided, 1 5/8” O.D. Pipe, Aluminum, Portable.
US 158H-U8	8’ ADA Table, 171 Lbs., Double Sided, 1 5/8” O.D. Pipe, Untreated Pine, Portable.
US 158H -PT8	8’ ADA Table, 171 Lbs., Double Sided, 1 5/8” O.D. Pipe, Treated Pine, Portable.
US 158H -T8	8’ ADA Table, 171 Lbs., Double Sided, 1 5/8” O.D. Pipe, Redwood Stained Pine, Portable.
US 158H -A8	8’ ADA Table, 134 Lbs., Double Sided, 2 3/8” O.D. Pipe,, Aluminum, Portable.
US 238HS-U8	8’ ADA Table, 203 Lbs., One Sided, 2 3/8” O.D. Pipe Untreated Pine, Portable.
US 238HS -PT8	8’ ADA Table, 203 Lbs., One Sided, 2 3/8” O.D. Pipe Treated Pine, Portable.
US 238HS -T8	8’ ADA Table, 203 Lbs., One Sided, 2 3/8” O.D. Pipe, Redwood Stained Pine, Portable.
US 238HS -A8	8’ ADA Table, 166 Lbs., One Sided, 2 3/8” O.D. Pipe, Aluminum, Portable.
US 238H-U8	8’ ADA Table, 194 Lbs., Double Sided, 2 3/8” O.D. Pipe, Untreated Pine, Portable.
US 238H -PT8	8’ ADA Table, 194 Lbs., Double Sided, 2 3/8” O.D. Pipe, Treated Pine, Portable.
US 238H -T8	8’ ADA Table, 194 Lbs., Double Sided, 2 3/8” O.D. Pipe, Redwood Stained Pine, Portable.
US 238H -A8	8’ ADA Table, 157 Lbs., Double Sided, 2 3/8” O.D. Pipe, Aluminum, Portable.

8' Single Sided ADA Table

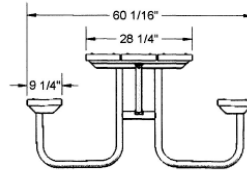
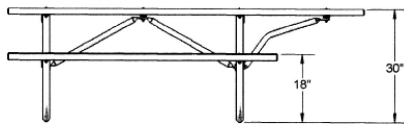
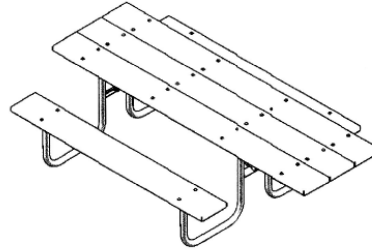
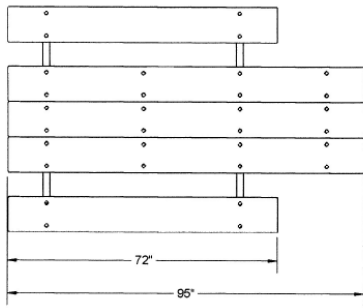

8' Double Sided ADA Table

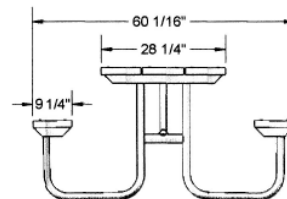
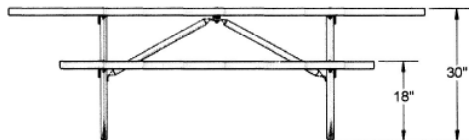
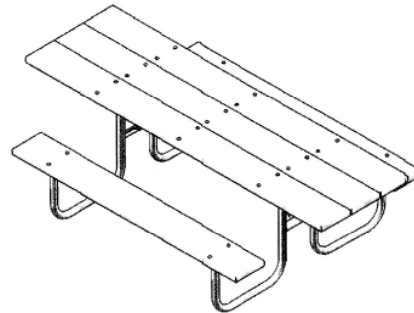
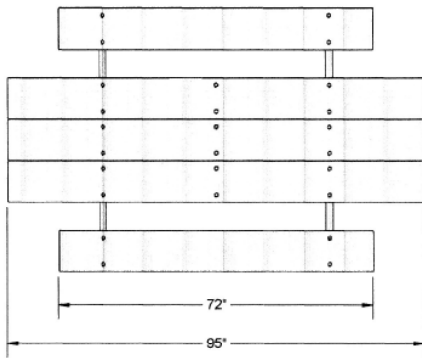

National Outdoor Furniture
1210 W. Main Street #296
Riverhead, N.Y. 11901

PHONE (888) 663-4621
E-MAIL nofinc1@gmail.com

www.nationaloutdoorfurniture.com